

# BZ-20-152

## TECHNICAL DATA:

### Max Power Consumption

	12 volt	24 volt
Motor	260 A	125 A
Lowering valve	6,4 A	2,4 A
Shift valve	6,4 A	2,4 A
Solenoid	1,5 A	0,9 A
Wire cross-sections:		
Control current	1,5 mm <sup>2</sup>	1,5 mm <sup>2</sup>
Battery cable	35 mm <sup>2</sup>	35 mm <sup>2</sup>
<b>Minimum battery capacity 160 Ah</b>		

### LOADING DIAGRAM

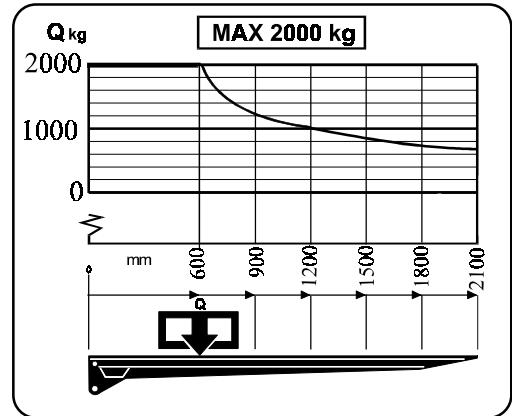

### Installation dimensions

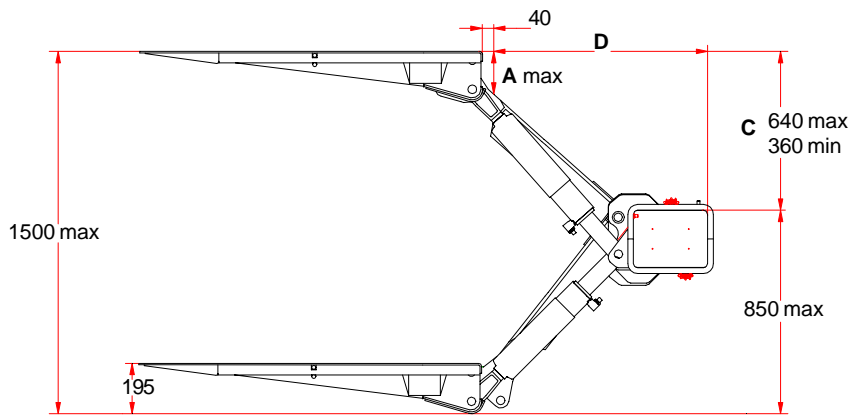

A	C	D
147	640	837
140	600	878
130	550	922
120	500	959
109	450	992
101	400	1020
94	360	1039

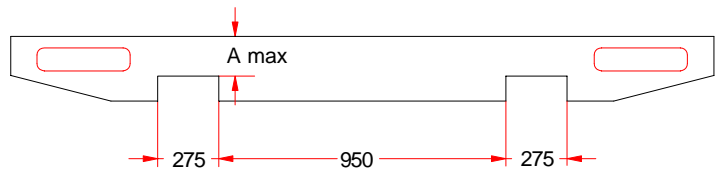
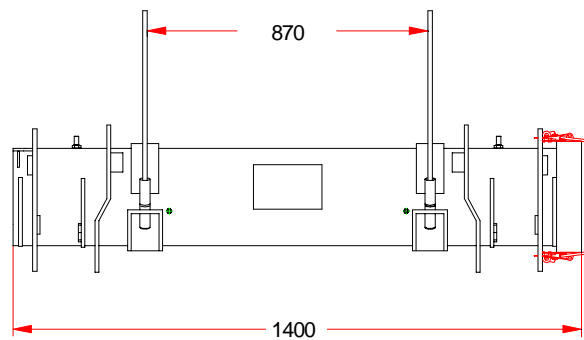
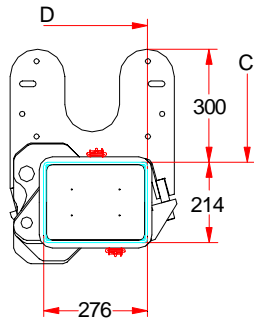

**ZEPRO**  
Z-LYFTEN PRODUKTION AB



ZEPRO Sales Tel:- +46 150 489 550

Fax:- +46 150 489 551, +46 150 489 566

E-mail:- info@z-lyften.se, Internet:- www.z-lyften.se, www.zepro.com